

Ultrafast Recovery Modules UFT125, 126 & 127

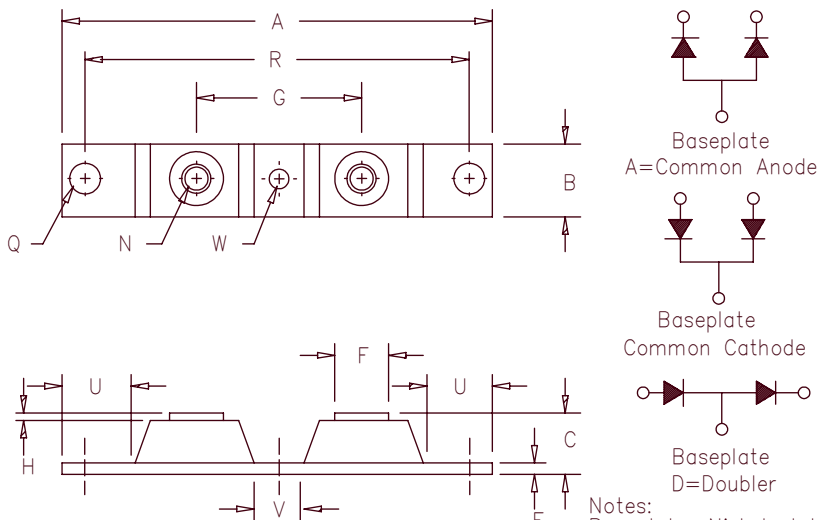

Dim.	Inches		Millimeters		Notes
	Min.	Max.	Min.	Max.	
A	---	3.630	---	92.20	
B	0.700	0.800	17.78	20.32	
C	---	0.630	---	16.00	
E	0.120	0.130	3.05	3.30	
F	0.490	0.510	12.45	12.95	
G	1.375	BSC	34.92	BSC	
H	0.010	---	0.25	---	
N	---	---	---	---	1/4-20
Q	0.275	0.290	6.99	7.37	Dia.
R	3.150	BSC	80.01	BSC	
U	0.600	---	15.24	---	
V	0.312	0.340	7.92	8.64	
W	0.180	0.195	4.57	4.95	Dia.

Notes:
Baseplate: Nickel plated copper; common cathode

Microsemi Catalog Number	Working Peak Reverse Voltage	Repetitive Peak Reverse Voltage
UFT12505*	50V	50V
UFT12510*	100V	100V
UFT12515*	150V	150V
UFT12520*	200V	200V
UFT12620*	200V	200V
UFT12630*	300V	300V
UFT12640*	400V	400V
UFT12650*	500V	500V
UFT12760*	600V	600V
UFT12770*	700V	700V
UFT12780*	800V	800V

Add Suffix A for Common Anode, D for Doubler

- Ultra Fast Recovery
- 175°C Junction Temperature
- V_{RRM} 50 to 800 Volts
- 120 Amps Current Rating
- 2 X 60 Amp current rating
- ROHS Compliant

Electrical Characteristics

	UFT125	UFT126	UFT127	
Average forward current per pkg	$I_F(AV)$ 120A	120A	120A	Square Wave
Average forward current per leg	$I_F(AV)$ 60A	60A	60A	Square Wave
Case Temperature	T_C 130°C	115°C	114°C	$R_{\theta JC} = 0.85^\circ C/W$
Maximum surge current per leg	I_{FSM} 800A	700A	600A	8.3ms, half sine, $T_J = 175^\circ C$
Max peak forward voltage per leg	V_{FM} .975V	1.25V	1.35V	$I_{FM} = 60A, T_J = 25^\circ C^*$
Max reverse recovery time per leg	t_{rr} 40ns	60ns	80ns	1/2A, 1A, 1/4A, $T_J = 25^\circ C$
Max peak reverse current per leg	I_{RM} ---	2.0ma	---	$V_{RRM}, T_J = 125^\circ C^*$
Max peak reverse current per leg	I_{RM} ---	30 μ a	---	$V_{RRM}, T_J = 25^\circ C$
Typical Junction capacitance	C_J 270pF	200pF	160pF	$V_R = 10V, T_J = 25^\circ C$

*Pulse test: Pulse width 300 μ sec, Duty cycle 2%

Thermal and Mechanical Characteristics

Storage temp range	T_{STG}	-55°C to 175°C
Operating junction temp range	T_J	-55°C to 175°C
Max thermal resistance per leg	$R_{\theta JC}$	0.85°C/W Junction to case
Max thermal resistance per pkg	$R_{\theta JC}$	0.425°C/W Junction to case
Typical thermal resistance	$R_{\theta CS}$	0.08°C/W Case to sink
Terminal Torque		35-50 inch pounds
Mounting Base Torque - outside holes		30-40 inch pounds
Mounting Base Torque - (center hole)		8-10 inch pounds
center bolt must be torqued first		
Weight		2.8 ounces (75 grams) typical

UFT125

Figure 1
Typical Forward Characteristics – Per Leg

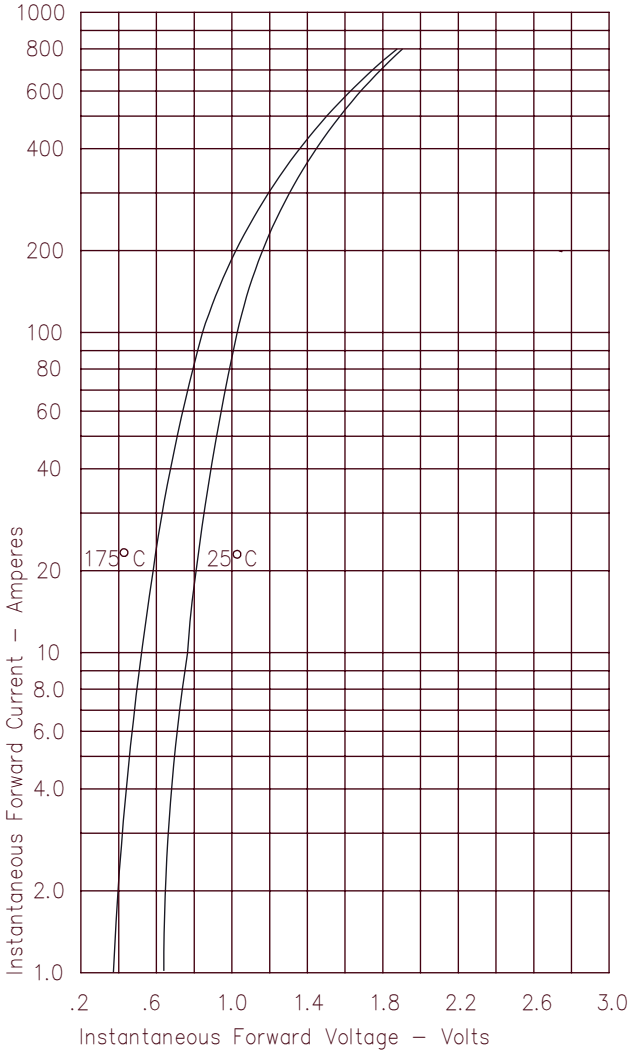

Figure 3
Typical Junction Capacitance – Per Leg

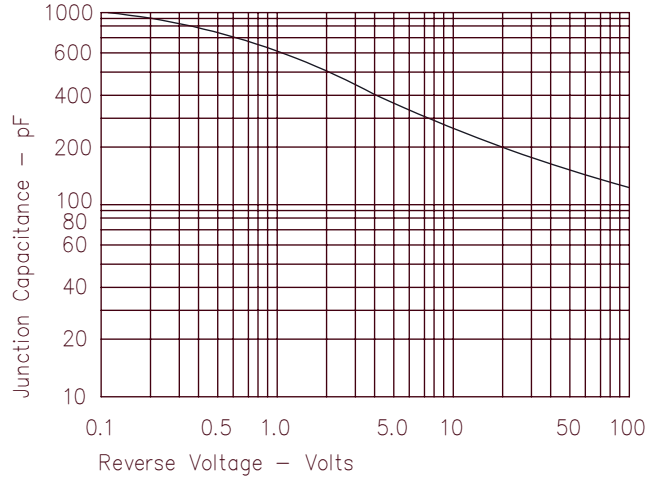

Figure 4
Forward Current Derating – Per Leg

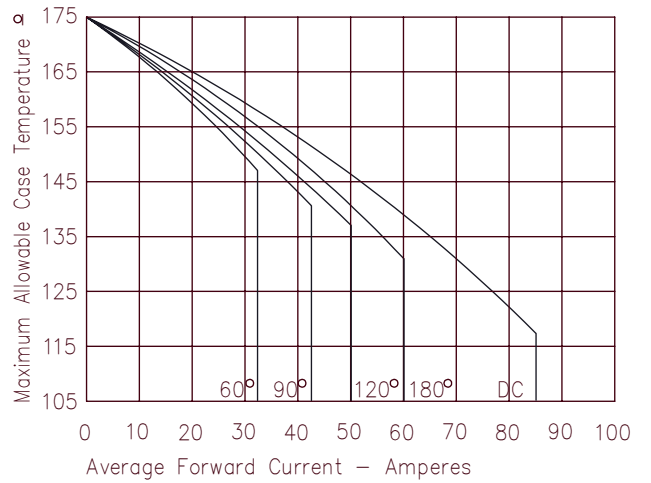

Figure 2
Typical Reverse Characteristics – Per Leg

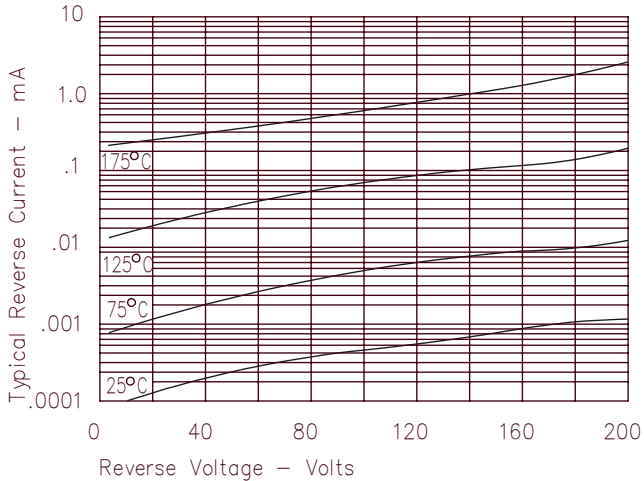
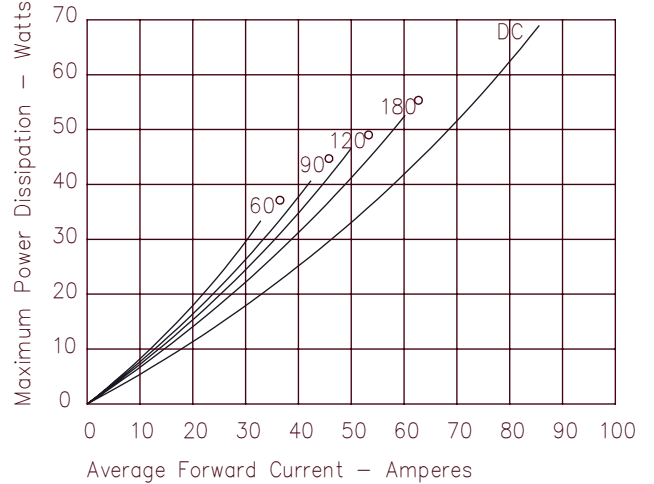

Figure 5
Maximum Forward Power Dissipation – Per Leg



UFT126

Figure 1
Typical Forward Characteristics – Per Leg

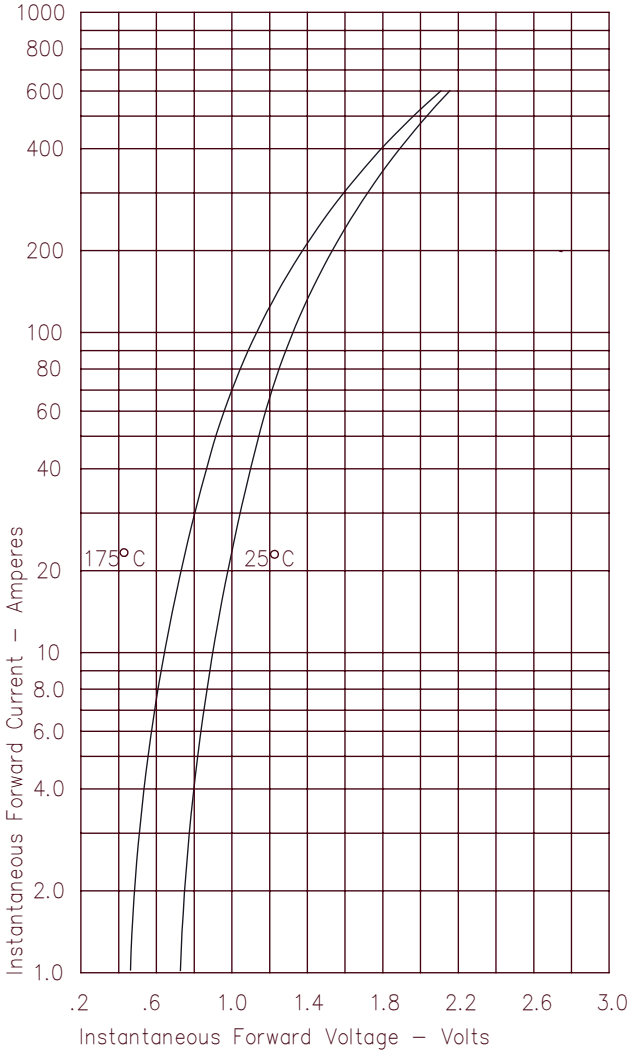

Figure 3
Typical Junction Capacitance – Per Leg

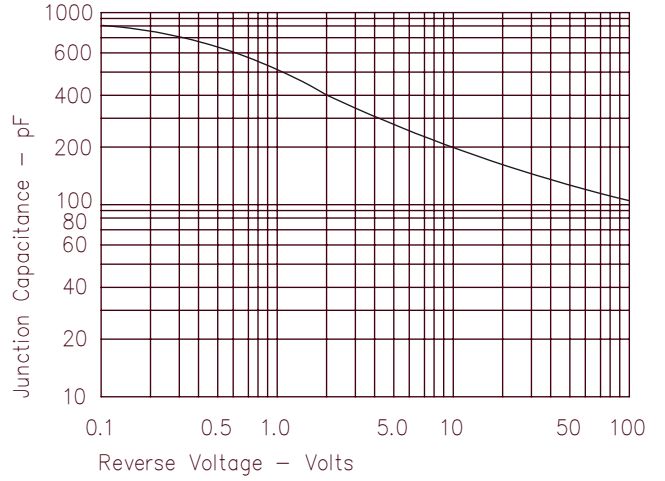

Figure 4
Forward Current Derating – Per Leg

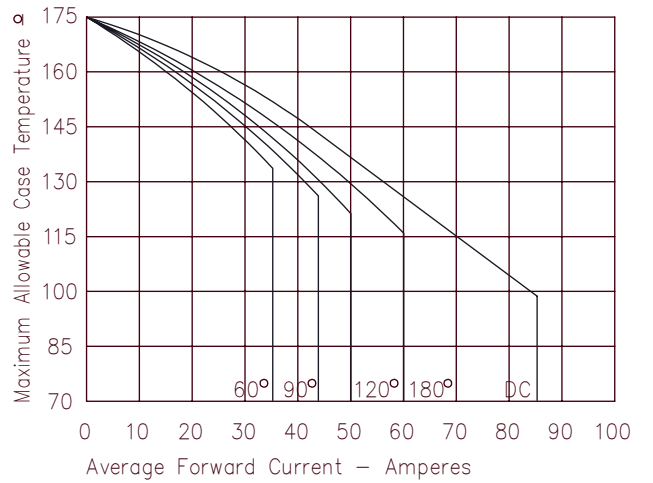

Figure 2
Typical Reverse Characteristics – Per Leg

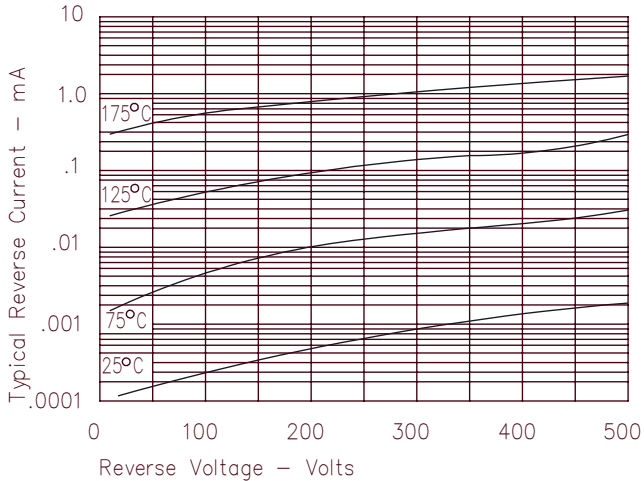
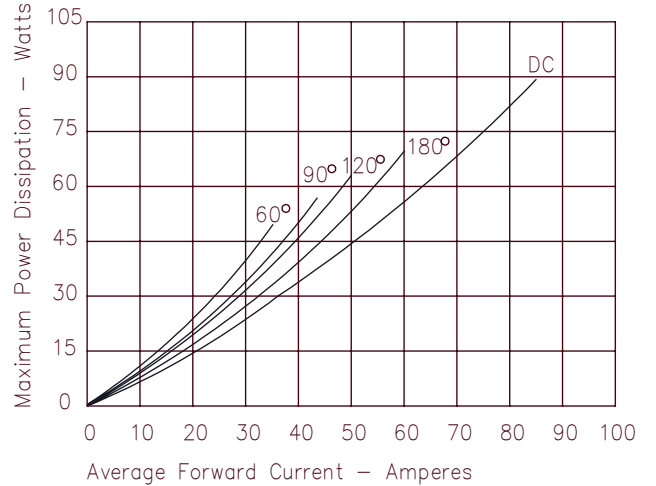

Figure 5
Maximum Forward Power Dissipation – Per Leg



UFT127

Figure 1
Typical Forward Characteristics – Per Leg

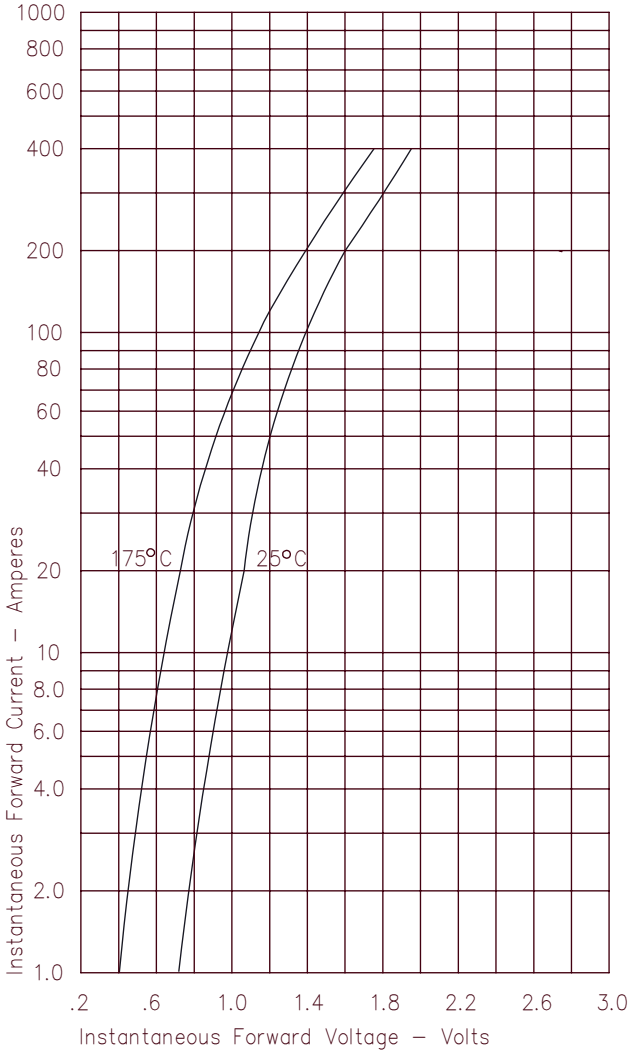

Figure 3
Typical Junction Capacitance – Per Leg

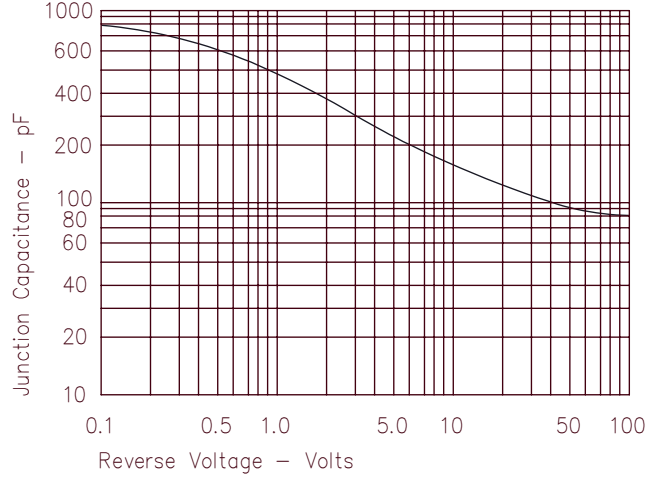

Figure 4
Forward Current Derating – Per Leg

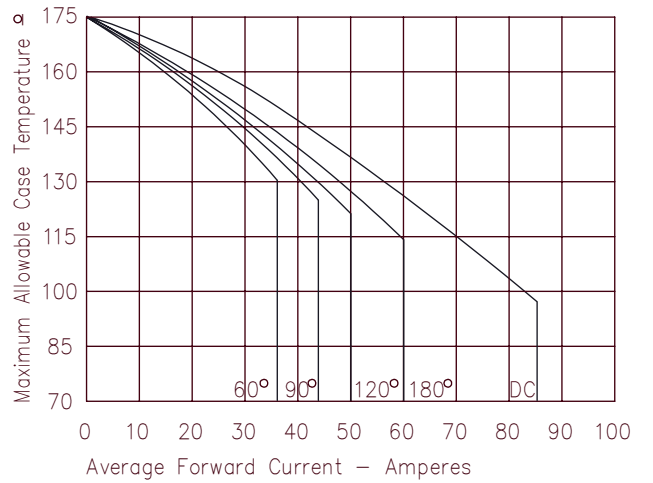

Figure 2
Typical Reverse Characteristics – Per Leg

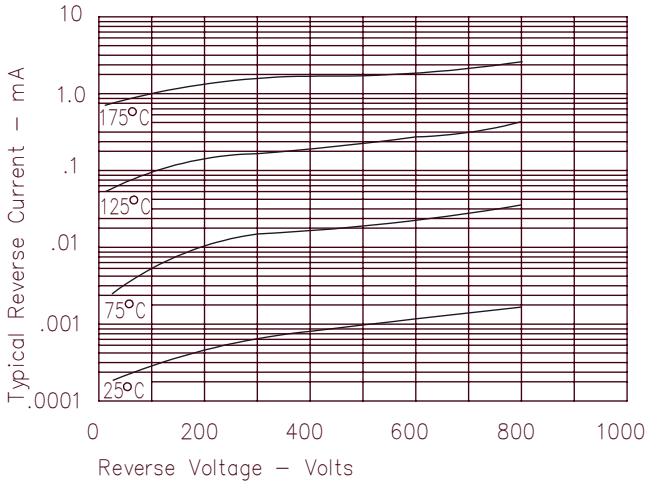

Figure 5
Maximum Forward Power Dissipation – Per Leg

